



Produktkatalog

Decor glaseslag

Decor beslag

Punktbeslag



Beskrivelse

MAB decor punktbeslag

Med MAB Decor punktbeslagene har du selv muligheden for at bestemme lige præcis hvordan punktbeslaget skal udformes, om det er med 20 eller 50 mm. Afstand bag glasset, og om fronten er undersænket i glasset og der med plan overflade, eller om der skal anvendes en cylindrisk punktbeslag i Ø30 eller Ø40 mm.

Kontakt os for muligheder eller løsningsforslag.

Kontakt os for DWG tegninger og specifikke tekniske detaljer.

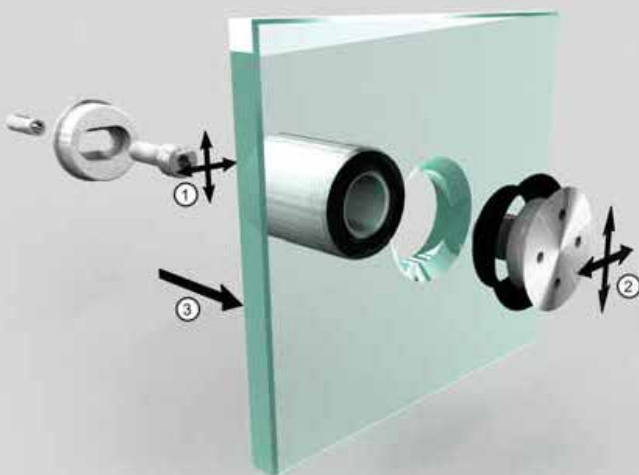

INFORMATION PUNKTBESLAG

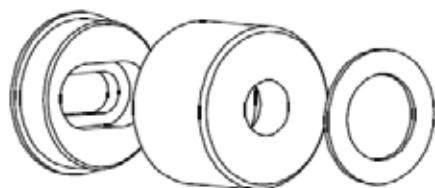

Underlags skive

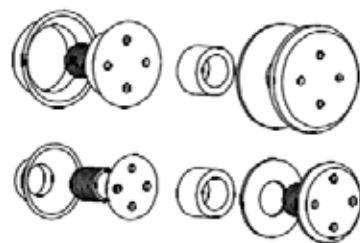

Front

Punktbeslagene består således af 2 dele, Underlags skiven som er den bagerste del, som er afstanden mellem underlaget og glasset, og fronten som er forreste del, denne er valgfri udførelse, disse betegnes her efter som Ø36 og Ø28 Undersænket eller Ø40 og Ø30 cylindrisk.

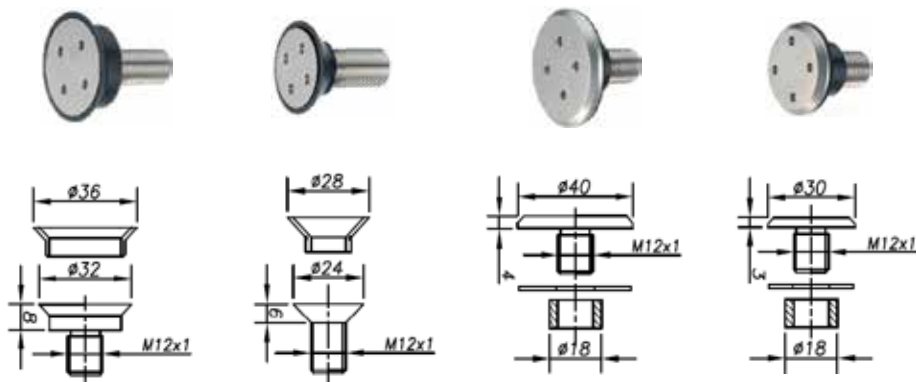

Den forreste del af punktbeslagene i dette kapitel, kan i de fleste tilfælde leveres i 4 forskellige udførelser, Ø36 og Ø28 mm. undersænket og Ø40 og Ø30 mm. cylindrisk. Man vælger således selv afstandes stykket mellem glasset og underlaget, og fronten af punktbeslaget.

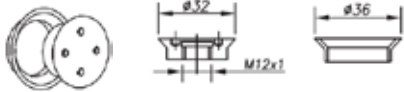

Front til 3 og 14 mm. Undersænk

Rustfri			
Vare nr.	Diameter	Glas tykkelse	Pakning
020100	Ø36 mm.	8 mm.	1 stk.
020101	Ø36 mm.	10 mm.	1 stk.



Front til 3 og 14 mm. Cylindrisk.

Rustfri			
Vare nr.	Diameter	Glas tykkelse	Pakning
020102	Ø40 mm.	8 mm.	1 stk.
020103	Ø40 mm.	10 mm.	1 stk.

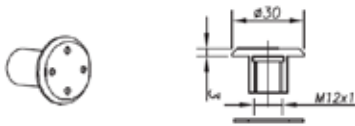

Front til 3 og 14 mm. Cylindrisk.

Rustfri			
Vare nr.	Diameter	Glas tykkelse	Pakning
020105	Ø30 mm.	8 mm.	1 stk.
020106	Ø30 mm.	10 mm.	1 stk.



Underlags skive 3 og 14 mm.

Rustfri				
Vare nr.	Afstand	Max Kg.	Diameter	Pakning
020108	3 mm.	30 kg.	Ø35 mm.	1 stk.
020109	14 mm.	50 kg.	Ø35 mm.	1 stk.



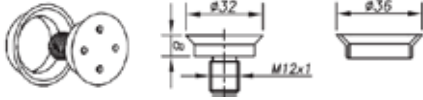

Front undersænket, for 20 til 100 mm.

Rustfri				
Vare nr.	Diameter	Glas tykkelse	Pakning	
020110	Ø36 mm.	8-12,76 mm.	1 stk.	
020111	Ø36 mm.	12,76-17,52 mm.	1 stk.	
020112	Ø36 mm.	19-22 mm.	1 stk.	

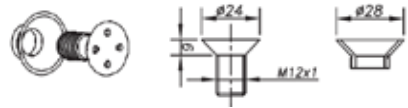

Front undersænket, for 20 til 100 mm.

Rustfri				
Vare nr.	Diameter	Glas tykkelse	Pakning	
020115	Ø28 mm.	8-12,76 mm.	1 stk.	
020116	Ø28 mm.	12,76-17,52 mm.	1 stk.	
020117	Ø28 mm.	19-22 mm.	1 stk.	

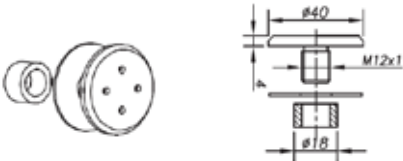

Front cylindrisk, for 20 til 100 mm.

Rustfri				
Vare nr.	Diameter	Glas tykkelse	Pakning	
020120	Ø40 mm.	8-12,76 mm.	1 stk.	
020121	Ø40 mm.	12,76-17,52 mm.	1 stk.	
020122	Ø40 mm.	19-22 mm.	1 stk.	

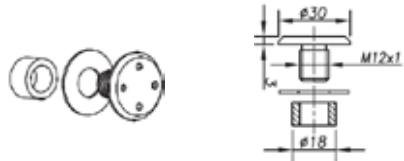

Front cylindrisk, for 20 til 100 mm.

Rustfri				
Vare nr.	Diameter	Glas tykkelse	Pakning	
020125	Ø30 mm.	8-12,76 mm.	1 stk.	
020126	Ø30 mm.	12,76-17,52 mm.	1 stk.	
020127	Ø30 mm.	19-22 mm.	1 stk.	

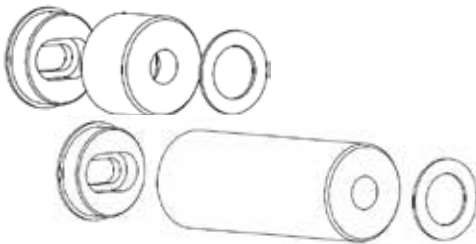

Underlags skive 20 til 100 mm.

Rustfri				
Vare nr.	Afstand	Max Kg.	Diameter	Pakning
020130	20 mm.	50 kg.	Ø35 mm.	1 stk.
020131	30 mm.	50 kg.	Ø35 mm.	1 stk.
020132	40 mm.	50 kg.	Ø35 mm.	1 stk.
020133	50 mm.	50 kg.	Ø35 mm.	1 stk.
020134	60 mm.	50 kg.	Ø35 mm.	1 stk.
020135	70 mm.	50 kg.	Ø35 mm.	1 stk.
020136	80 mm.	50 kg.	Ø35 mm.	1 stk.
020137	100 mm.	50 kg.	Ø35 mm.	1 stk.



Decor beslag

Punktbeslag

Beskrivelse

MAB decor samlebeslag

MAB Decor samlebeslagene består som punktbeslagene af 2 dele, den ene del er punktbeslaget den anden del er selve beslaget. Det giver således også her muligheden for man selv kan sammen sætte beslaget som man ønsker det.

Kontakt os for muligheder eller løsningsforslag.

Kontakt os for DWG tegninger og specifikke tekniske detaljer.



INFORMATION SAMLEBESLAG

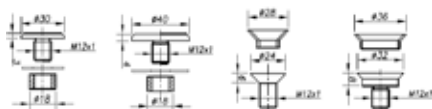

Den forreste del af punktbeslagene kan som tidligere leveres i 4 forskellige udførelser, Ø36 og Ø28 mm. Undersænket og Ø40 og Ø30 mm. Cylindrisk. Man vælger således selv afstandes stykket mellem glasset og underlaget, og fronten af punktbeslaget.

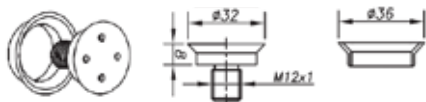

Front undersænket, for 20 til 100 mm.

Rustfri			
Vare nr.	Diameter	Glas tykkelse	Pakning
020140	Ø36 mm.	8-12,76 mm.	1 stk.
020141	Ø36 mm.	12,76-17,52 mm.	1 stk.
020142	Ø36 mm.	19-22 mm.	1 stk.

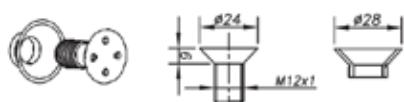

Front undersænket, for 20 til 100 mm.

Rustfri			
Vare nr.	Diameter	Glas tykkelse	Pakning
020145	Ø28 mm.	8-12,76 mm.	1 stk.
020146	Ø28 mm.	12,76-17,52 mm.	1 stk.
020147	Ø28 mm.	19-22 mm.	1 stk.

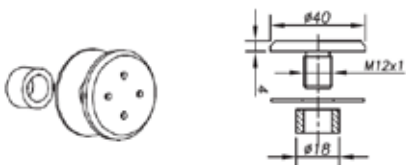

Front cylindrisk, for 20 til 100 mm.

Rustfri			
Vare nr.	Diameter	Glas tykkelse	Pakning
020150	Ø40 mm.	8-12,76 mm.	1 stk.
020151	Ø40 mm.	12,76-17,52 mm.	1 stk.
020152	Ø40 mm.	19-22 mm.	1 stk.

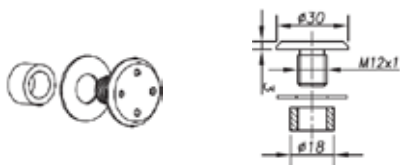

Front cylindrisk, for 20 til 100 mm.

Rustfri			
Vare nr.	Diameter	Glas tykkelse	Pakning
020155	Ø30 mm.	8-12,76 mm.	1 stk.
020156	Ø30 mm.	12,76-17,52 mm.	1 stk.
020157	Ø30 mm.	19-22 mm.	1 stk.

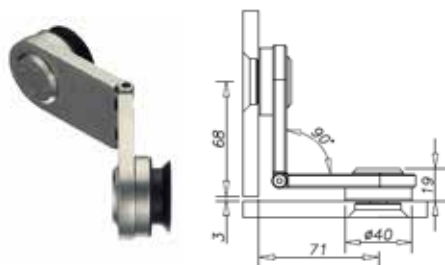

Juster bar vinkel 90 - 180°

Rustfri			
Vare nr.	Type	Max Kg.	Pakning
020160	justerbar	30 kg.	1 stk.

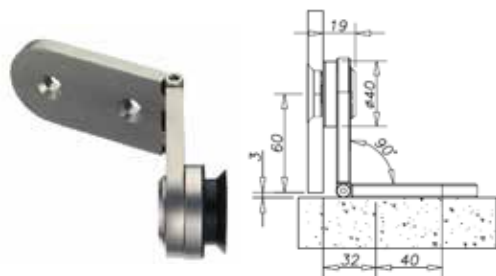

Juster bar vinkel 90 - 180°

Rustfri			
Vare nr.	Type	Max Kg.	Pakning
020161	justerbar	30 kg.	1 stk.

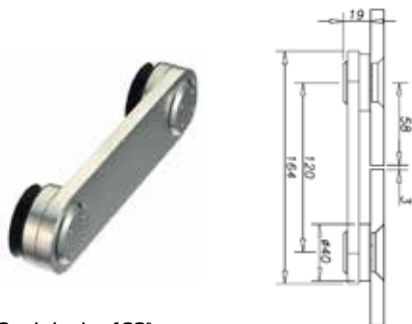

Samle beslag 180°

Rustfri			
Vare nr.	Type	Max Kg.	Pakning
020162	180°	30 kg.	1 stk.



Vinkel 90°

Rustfri			
Vare nr.	Type	Max Kg.	Pakning
020163	90°	30 kg.	1 stk.

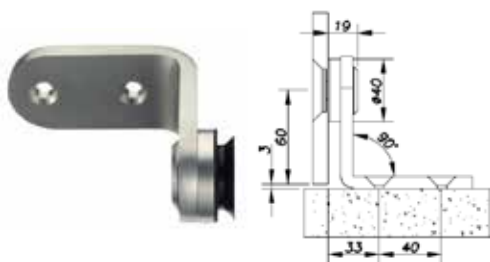

Vinkel 90°

Rustfri			
Vare nr.	Type	Max Kg.	Pakning
020163	90°	30 kg.	1 stk.



9

Decor beslag

Spiders

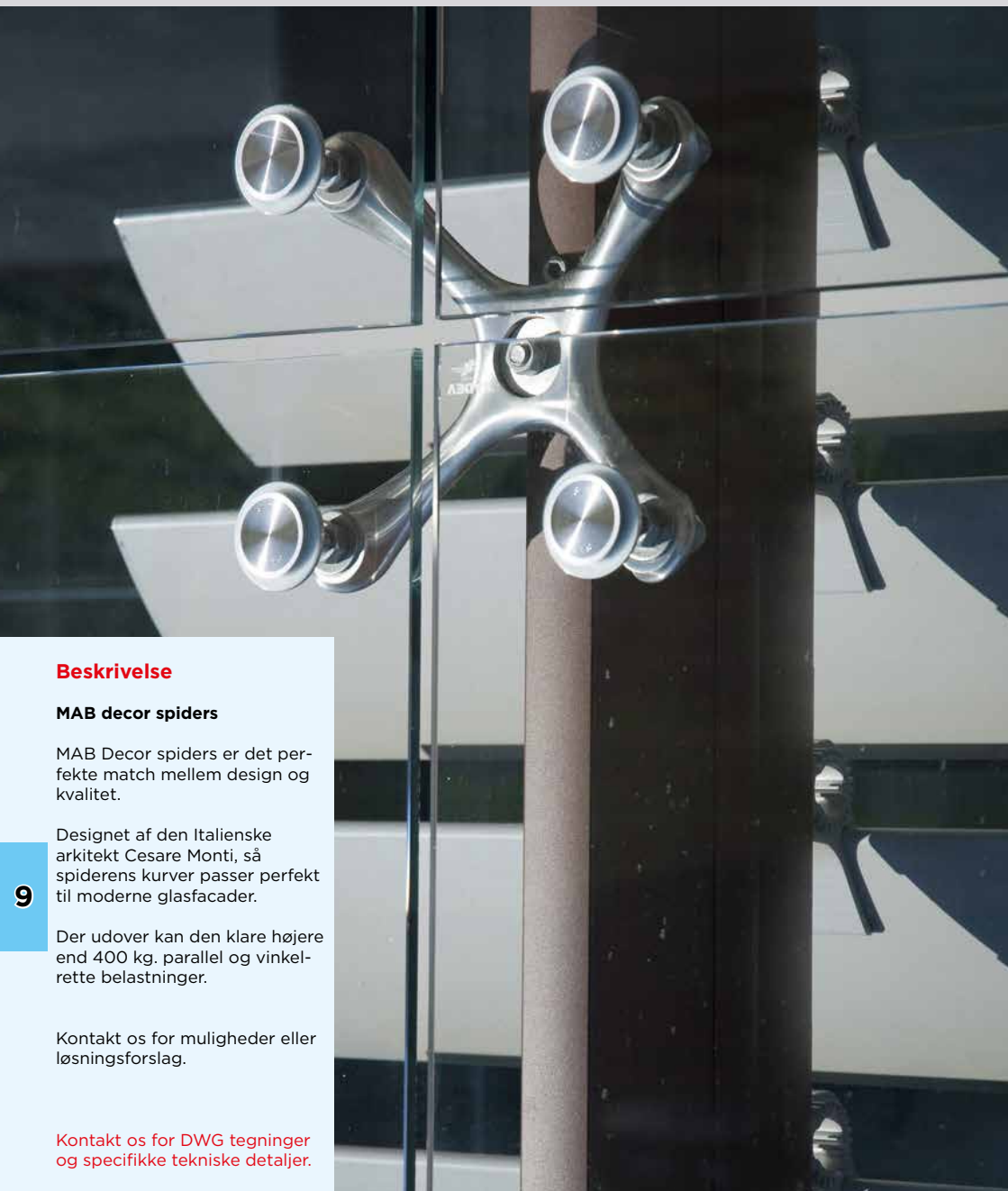

Beskrivelse

MAB decor spiders

MAB Decor spiders er det perfekte match mellem design og kvalitet.

Designet af den Italienske arkitekt Cesare Monti, så spiderens kurver passer perfekt til moderne glasfacader.

Der udover kan den klare højere end 400 kg. parallel og vinkelrette belastninger.

Kontakt os for muligheder eller løsningsforslag.

Kontakt os for DWG tegninger og specifikke tekniske detaljer.

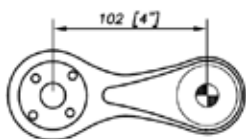

1 arms spider

Rustfri		
Vare nr.	Type	Pakning
020200	180°	1 stk.

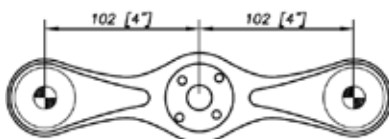

2 armet spider

Rustfri		
Vare nr.	Type	Pakning
020201	180°	1 stk.

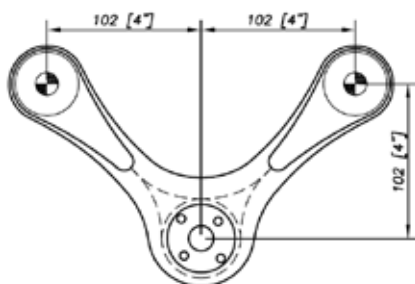

2 armet spider

Rustfri		
Vare nr.	Type	Pakning
020202	90°	1 stk.

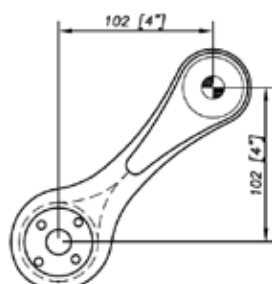

1 arms spider

Rustfri		
Vare nr.	Type	Pakning
020203	90°	1 stk.

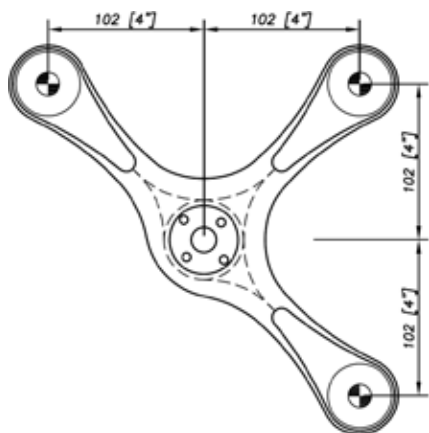

3 armet spider

Rustfri		
Vare nr.	Type	Pakning
020204	3 arme	1 stk.

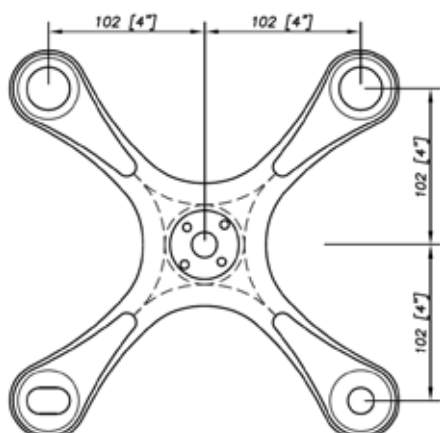

4 armet spider

Rustfri		
Vare nr.	Type	Pakning
020205	4 arme	1 stk.



Punktbeslag for spider

Rustfri				
Vare nr.	Type	Model	Ø	Pakning
020210	Fast	R 1003	50 mm.	1 stk.
020211	Fast	R 1003	60 mm.	1 stk.
020212	Fast	R 1003	70 mm.	

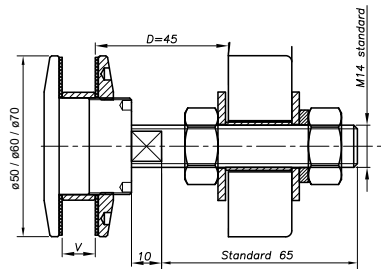

Punktbeslag for spider

Rustfri				
Vare nr.	Type	Model	Ø	Pakning
020215	Justerbar	V 2005	50 mm.	1 stk.
020216	Justerbar	V 2005	60 mm.	1 stk.
020217	Justerbar	V 2005	70 mm.	1 stk.

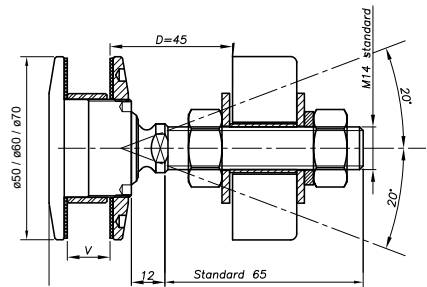

9

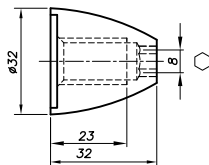

Møtrik for punktbeslag

Rustfri		
Vare nr.	Type	Pakning
020220	Kegleformet	1 stk.

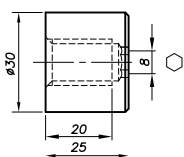

Møtrik for punktbeslag

Rustfri		
Vare nr.	Type	Pakning
020221	Cylindrisk	1 stk.



Decor beslag

Skydedørsbeslag



Beskrivelse

MAB decor skydedøre

MAB Decor skydedørs system er både design og god værdi for pengene.

9

Nem installation takket være mange de mange justerings muligheder.

Løbeskinne er boret og fastgjort fra bagsiden på væggen.

Kontakt os for muligheder eller løsningsforslag.

Kontakt os for DWG tegninger og specifikke tekniske detaljer.

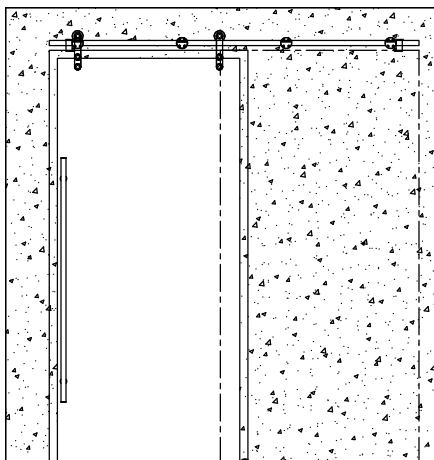



Decor medium skydedørs system

Rustfri

Vare nr. Type

020230 Decor medium system

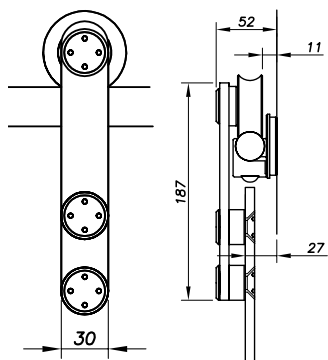

Decor direct rollers skydedørs system

Rustfri

Vare nr. Type

020235 Direct rollers system

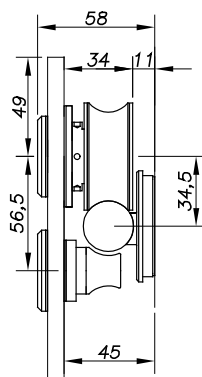

Decor træ skydedørs system

Rustfri

Vare nr. Type

020240 Træ rollers system

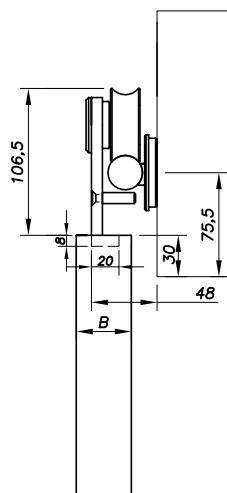

MBM || MAB

Bilstrupvej 2
7800 Skive
Danmark

Tel +45 70 20 66 70
info@mbm-mab.dk

www.mbm-mab.dk



BESØG
vores hjemmeside på
mbm-mab.dk