



# Produktkatalog

Dusch løsninger

# MAB integra

Kit-sæt, walk with us....



## Beskrivelse

### MAB integra dusch

8 MAB's nye serie af showers, fåes i 5 udgaver:

"Walk-in-side"  
"Walk-in-corner"  
"Walk-in-front"  
"Wall-to-wall"  
"Corner"

- Udført i poleret rustfrit stål i AISI 304 (A2)
- Firkant rør 25x25 mm. og 30x30 mm.
- Rør Ø20 og Ø30 mm.

For andre muligheder eller forespørgsel, kontakt os.



## Model "Walk-in-side"

Bestående af 1 støtte stang og 2 vægbeslag, udført i rustfrit stål AISI 304 som er højglans poleret.

Denne model er med beslag for 1 side glas, med en max bredde på 1200 mm. vi anbefaler en højde på 2000 mm.

Glas er ikke inkluderet, men bestilles separat se vores afsnit om glas.

## Model "Walk-in-side"

Dusch			
Vare nr.	Model	Type	Glas
037510	Ref. S01	Rør vinklet	8 mm.
037511	Ref. S02	Rør lodret	8 mm.
037512	Ref. SQ02	Firkantet vinklet	8 mm.
037513	Ref. SQ02	Firkantet lodret	8 mm.

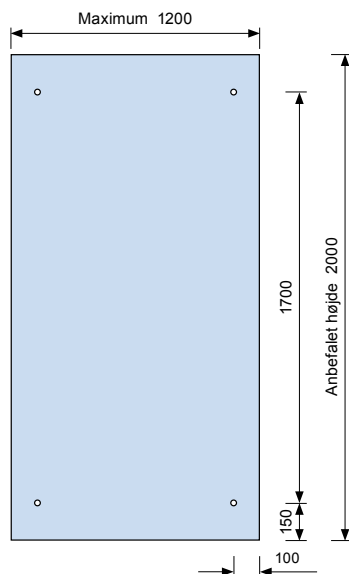

4 x ø12 huller i glasset  
8 mm hærdet glas

## Model "Walk-in-corner"

Bestående af 1 støtte stang og 2 vægbeslag og 2 hjørnebeslag, udført i rustfrit stål AISI 304 som er højglans poleret.

Modellen er med beslag for 2 side glas, med en max bredde på 1200/1000 mm. vi anbefaler en højde på 2000 mm.

Glas er ikke inkluderet, men bestilles separat se vores afsnit om glas.

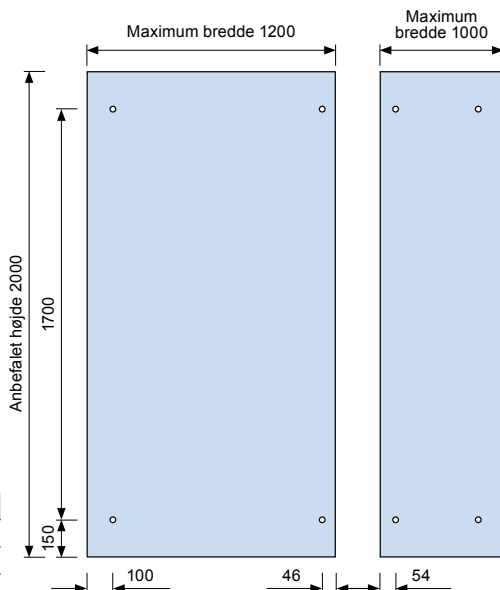

4 x  $\varnothing 12$  huller i glasset  
8 mm hærdet glas

## Model "Walk-in-corner"

Dusch			
Vare nr.	Model	Type	Glas
037514	Ref. S03	Rør vinklet	8 mm.
037515	Ref. S04	Rør lodret	8 mm.
037516	Ref. SQ03	Firkantet vinklet	8 mm.
037517	Ref. SQ04	Firkantet lodret	8 mm.



# MAB integra walk in front



Ref. S05



Ref. S06



Ref. SQ05



Ref. SQ06

## Model "Walk-in-front"

Bestående af 2 støtte stænger, udført i rustfrit stål AISI 304 som er højglans poleret.

Modellen er med beslag for 1 glas, med en max bredde på 1200 mm. vi anbefaler en højde på 2000 mm.

Glas er ikke inkluderet, men bestilles separat se vores afsnit om glas.

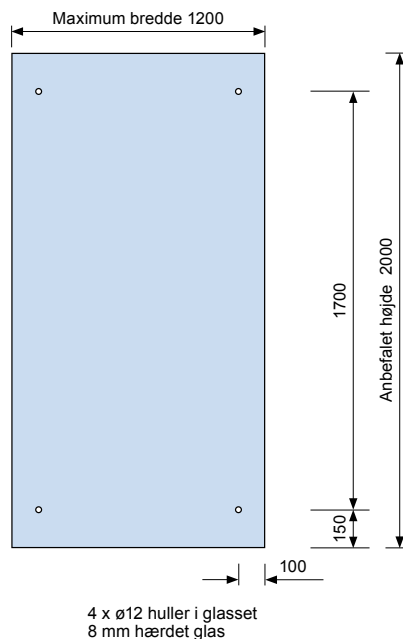

## Model "Walk-in-front"

Dusch			
Vare nr.	Model	Type	Glas
037518	Ref. S05	Rør vinklet	8 mm.
037519	Ref. S06	Rør lodret	8 mm.
037520	Ref. SQ05	Firkantet vinklet	8 mm.
037521	Ref. SQ06	Firkantet lodret	8 mm.



## Model "Wall-to-wall"

Bestående af 1 støtte stang og 2 vægbeslag og 2 hængsler, udført i rustfrit stål AISI 304 som er højglans poleret.

Modellen er med beslag for 1 side glas, og hængsler til lågen. Vi anbefaler en højde på 2000 mm.

Glas er ikke inkluderet, men bestilles separat se vores afsnit om glas.

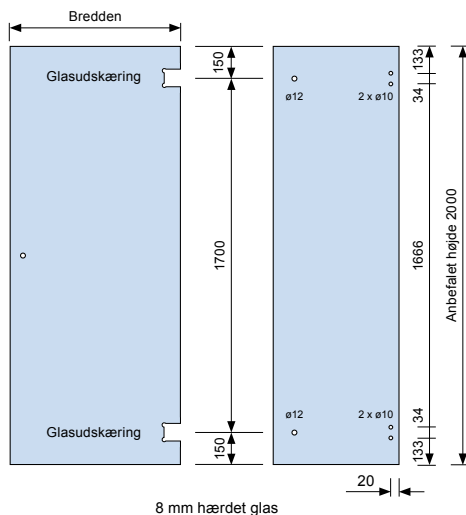

## Model "Wall-to-wall"

Dusch			
Vare nr.	Model	Type	Glas
037522	Ref. SQ10	Firkantet vinklet	8 mm.
037523	Ref. SQ11	Firkantet lodret	8 mm.

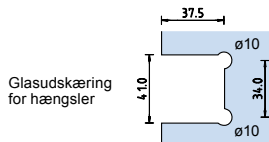

## Model "Corner"

Bestående af 1 støtte stang og 2 vægbeslag og 2 hængsler, udført i rustfrit stål AISI 304 som er højglans poleret.

Modellen er med beslag for 1 side glas, og hængsler til lågen. Vi anbefaler en højde på 2000 mm.

Glas er ikke inkluderet, men bestilles separat se vores afsnit om glas.

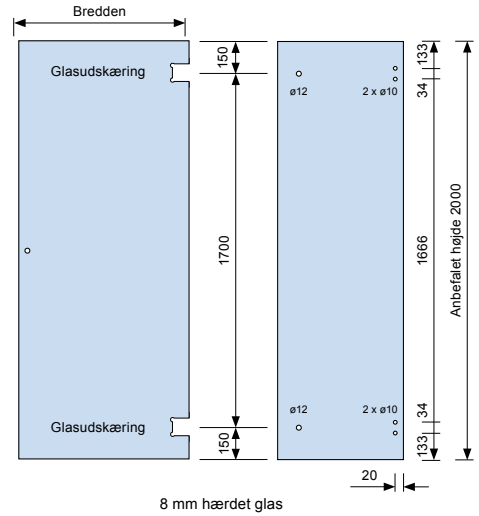

## Model "Corner"

Dusch			
Vare nr.	Model	Type	Glas
037524	Ref. SQ12	Firkantet vinklet	8 mm.
037525	Ref. SQ13	Firkantet lodret	8 mm.

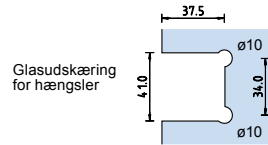

# MAB integra

## Wall to wall slide



8

### Beskrivelse

#### MAB integra dusch slide

MAB's nye serie af skydedørs showers, fåes i 6 forskellige kit set.

Disse sæt ses på de næste sider.

- Udført i poleret eller børstet rustfri stål i AISI 304 (A2)
- Rør Ø31 mm.

For andre muligheder eller forespørgsel, kontakt os.





## Standart tilbehør

Alt nødvendigt til montage er inkluderet i hvert kit set, så som gulvstyr, stop for løbevogne, skruer og popnitter.



**Køreskinne**  
- ø 31x2 mm.



**Løbevogn**  
- indbygget bøsning til justering af glas.



**Knop**  
- ø 28x10 mm.



**Vægbeslag for køreskinne**



**Clamp for fast glas**

# MAB integra wall to wall slide



## Model "Wall-to-wall slide" KIT1

For en enkelt skyde dør og et fast glas.

- Max dør vægt 30 kg.
- Skinnelængde 2000 mm.
- Højre eller venstre åbning.
- Inkl. Transparente tætningslister for 8 mm. glas.

## Wall-to-wall slide KIT1

Dusch

Vare nr.	Model	Finish	Længde	Glas
037530	Ref. 5001B	Poleret	2000 mm.	8 mm.
037531	Ref. 5001M	Børstet	2000 mm.	8 mm.

Glas er ikke inkluderet, men bestilles separat, se vores afsnit om glas.



## Model "Corner slide" KIT2

For to enkelte skyde døre og to faste glas.

- Max dør vægt 20 kg.
- Max mål 1000 x 1500 mm.
- Inkl. Transparente tætningslister for 8 mm. glas.
- Udføres på mål efter forespørgsel.

## Corner slide KIT2

Dusch

Vare nr.	Model	Finish	Max B/L	Glas
037532	Ref. 5002B	Poleret	1500 mm.	8 mm.
037533	Ref. 5002M	Børstet	1500 mm.	8 mm.

Glas er ikke inkluderet, men bestilles separat, se vores afsnit om glas.



## Model "Corner slide" KIT3

For en enkelt skyde dør og to faste glas.

- Max dør vægt 30 kg.
- Max mål 1000 x 1500 mm.
- Inkl. Transparente tætningslister for 8 mm. glas.
- Udføres på mål efter forespørgsel.

### Corner slide KIT3

Dusch				
Vare nr.	Model	Finish	Max B/L	Glas
037534	Ref. 5003B	Poleret	1500 mm.	8 mm.
037535	Ref. 5003M	Børstet	1500 mm.	8 mm.

Glas er ikke inkluderet, men bestilles separat, se vores afsnit om glas.



## Model "Wall-to-wall slide" KIT4

For to skyde døre og to faste glas.

- Max dør vægt 20 kg.
- Skinnelængde 2000 mm.
- Inkl. Transparente tætningslister for 8 mm. glas.

### Wall-to-wall slide KIT4

Dusch				
Vare nr.	Model	Finish	Længde	Glas
037536	Ref. 5004B	Poleret	2000 mm.	8 mm.
037537	Ref. 5004M	Børstet	2000 mm.	8 mm.

Glas er ikke inkluderet, men bestilles separat, se vores afsnit om glas.

# MAB integra wall to wall slide



## Model "Wall-to-glass slide" KIT5

For en enkelt skyde dør og to faste glas.

- Max dør vægt 30 kg.
- Skinnelængde 2000 mm.
- Inkl. Transparente tætningslister for 8 mm. glas.

## Wall-to-wall slide KIT5

Dusch				
Vare nr.	Model	Finish	Længde	Glas
037538	Ref. 5005B	Poleret	2000 mm.	8 mm.
037539	Ref. 5005M	Børstet	2000 mm.	8 mm.

Glas er ikke inkluderet, men bestilles separat, se vores afsnit om glas.



## Model "Wall-to-wall slide" KIT6

For en enkelt skyde dør og to faste glas.

- Max dør vægt 30 kg.
- Skinnelængde 2000 mm.
- Inkl. Transparente tætningslister for 8 mm. glas.

## Wall-towall slide KIT6

Dusch				
Vare nr.	Model	Finish	Længde	Glas
037540	Ref. 5006B	Poleret	2000 mm.	8 mm.
037541	Ref. 5006M	Børstet	2000 mm.	8 mm.

Glas er ikke inkluderet, men bestilles separat, se vores afsnit om glas.



# MAB integra

## Hæve/Sænke profil



8

### Beskrivelse

#### MAB integra hæve/sænke profil

- Profillængde 2220 mm.
- Kan kortes op på længden
- Glastykkelse 6 eller 8 mm.
- Max dør vægt 30 kg.
- Dørbredde Max 800 mm.
- Tætningsliste i bunden
- Ingen synlige skruer

For andre muligheder eller forespørgsel, kontakt os.

# MAB integra hæve/sænke profil

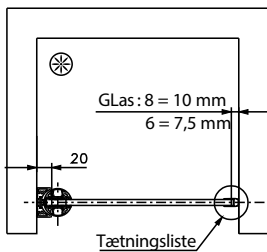
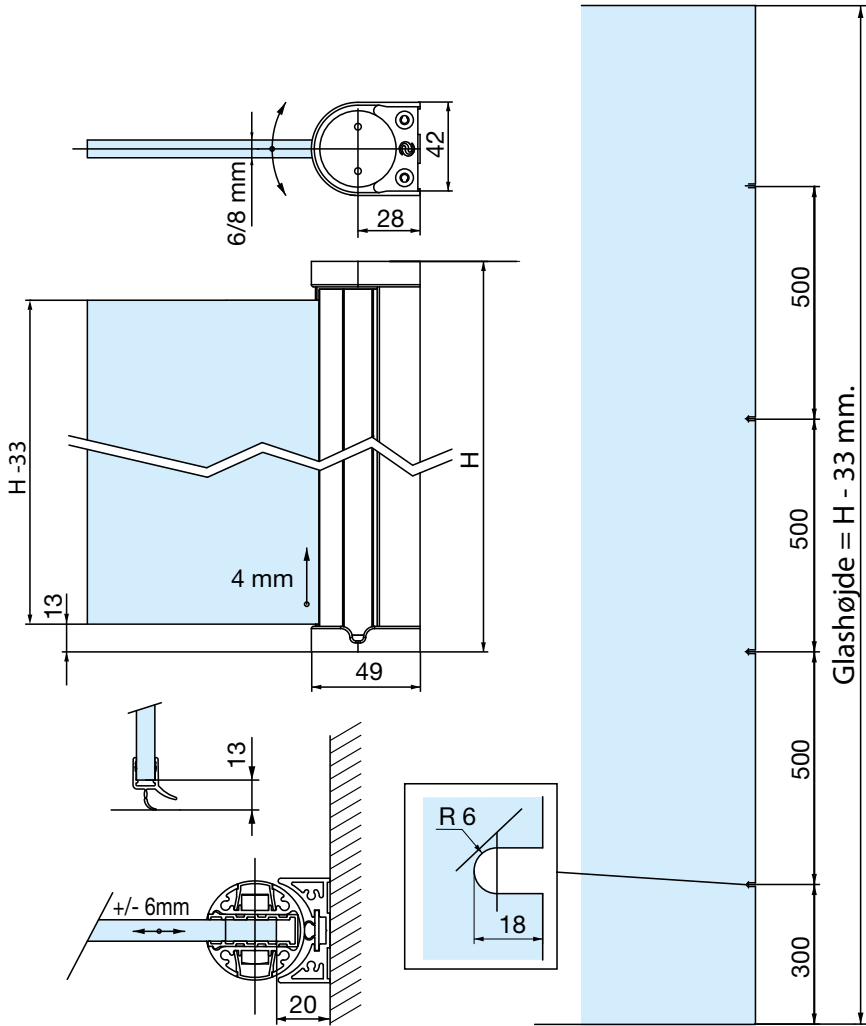

## MAB integra Hæve/sænke profil

Dusch			
Vare nr.	Længde	Finish	Glas
037430	2200 mm.	Krom	6-8 mm.

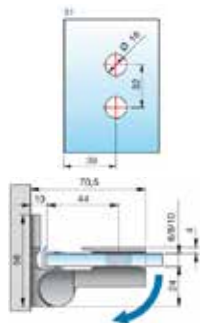
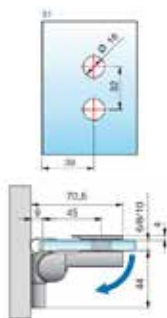

## Hængsel vægmontage

Dusch				
Vare nr.	Model	Finish	Side	Glas
037483	8150ZN5-L	Krom	Venstre	6-8-10 mm.
037484	8150ZN5-R	Krom	Højre	6-8-10 mm.

## Hængsel vægmontage

Dusch				
Vare nr.	Model	Finish	Side	Glas
037485	8369ZN5-L	Krom	Venstre	6-8-10 mm.
037486	8369ZN5-R	Krom	Højre	6-8-10 mm.

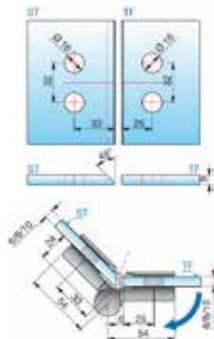
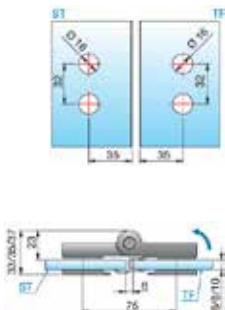

## Hængsel glas/glas montage

Dusch				
Vare nr.	Model	Finish	Side	Glas
037487	8363ZN5-L	Krom	Venstre	6-8-10 mm.
037488	8363ZN5-R	Krom	Højre	6-8-10 mm.

## Hængsel glas/glas montage

Dusch				
Vare nr.	Model	Finish	Side	Glas
037489	8365ZN5-L	Krom	Venstre	6-8-10 mm.
037490	8365ZN5-R	Krom	Højre	6-8-10 mm.

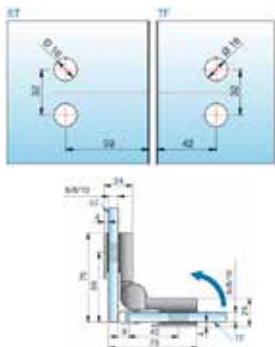

## Hængsel glas/glas montage

Dusch				
Vare nr.	Model	Finish	Side	Glas
037491	8367ZN5-L	Krom	Venstre	6-8-10 mm.
037492	8367ZN5-R	Krom	Højre	6-8-10 mm.



# MAB integra hæve/sænke hængsler

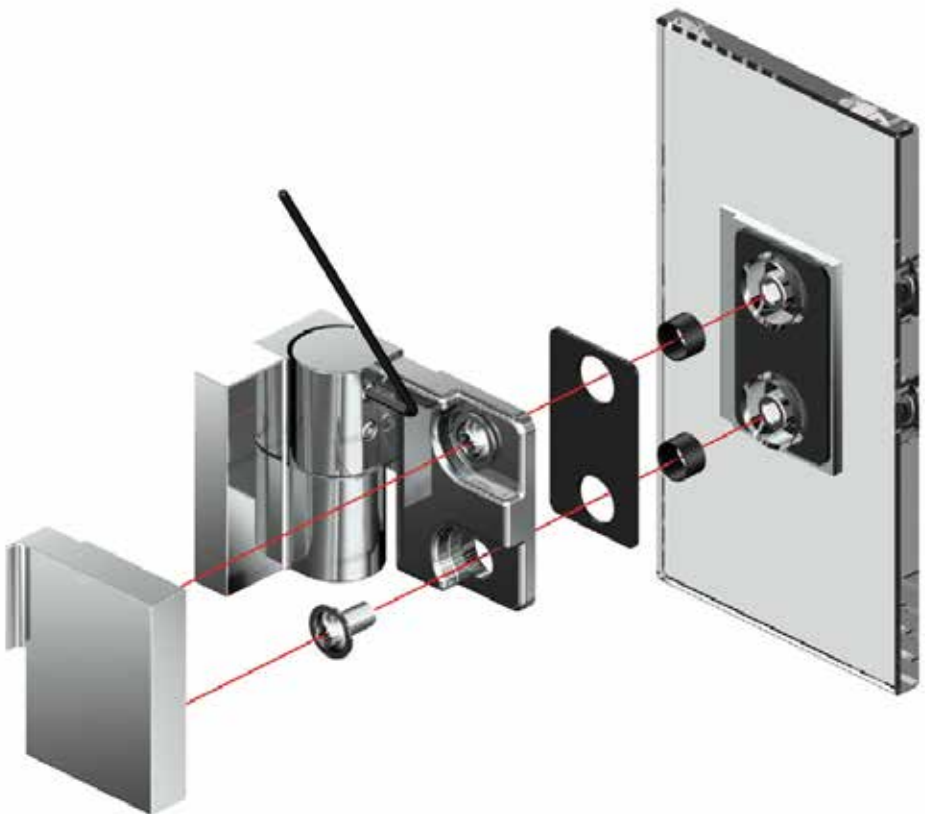

# MAB integra

## Flat bar system



8

### Beskrivelse

MAB Shower "FLAT BAR"

MAB's nye type skydedørs shower.

- Nem at tilpasse og nem installation.
- Lav vedligeholdelse.

For andre muligheder eller forespørgsel, kontakt os.

# MAB integra flat bar system

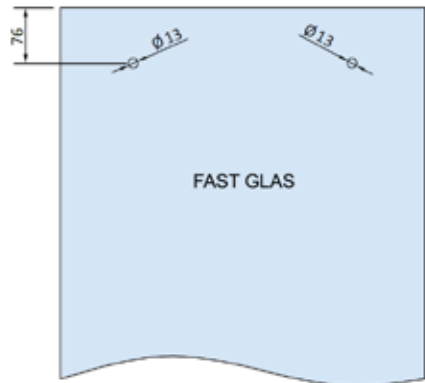
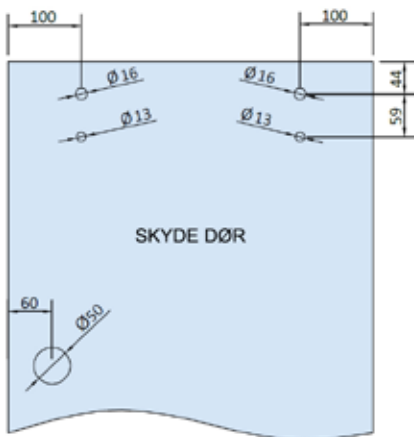



## SKYDEDØRS KIT

Skydedørs kittet kan indeholde en eller flere af de viste komponenter, indholdet af et kit variere alt efter modellen af løsningen.



Køreskinne  
037660



Ruller  
037661



Glasholdere sideglas  
037662



Stop  
037663



Vægbeslag  
037664



Antijump beslag  
037665



Hjørnebeslag  
037666



Gulvstyr  
037667



Greb  
037668

8

## SIDE GLAS KIT

Side glas kittet indeholder U-skiner i 2 standard længder 1000 og 2500 mm.



U-Skinne  
037669

## TÆTNINGS KIT

Tætnings kittet indeholder tætnings lister til at gøre at forhindre vand i at trænge ud.



H-profil  
037670



Bobbel profil  
037671



Magnet profil  
037672



Rustfri profil 15x15  
037673

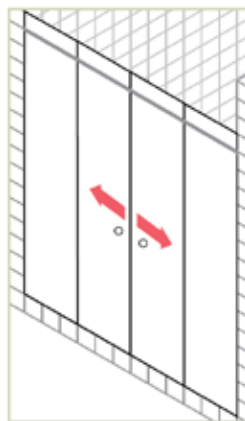
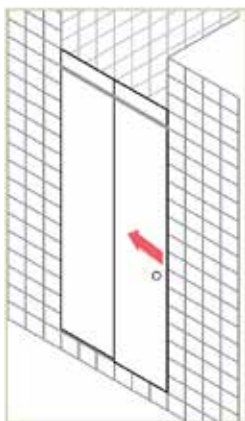

## Enkelt skydedør m/sideglas

Dusch		
Vare nr.	KIT sæt	Glas
037675	Skyde dørs KIT 1	8-10 mm.
037676	Side glas KIT 1	8-10 mm.
037677	Tætnings KIT 1	8-10 mm.

## Dobbelt skydedør m/2 sideglas

Dusch		
Vare nr.	KIT sæt	Glas
037678	Skyde dørs KIT 2	8-10 mm.
037679	Side glas KIT 2	8-10 mm.
037680	Tætnings KIT 2	8-10 mm.

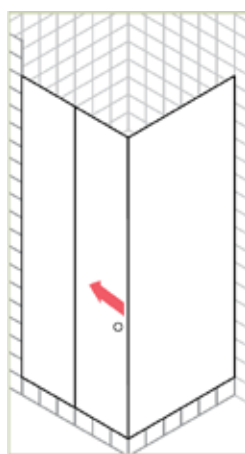
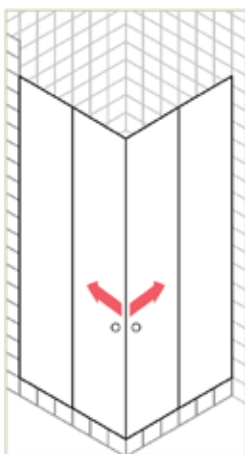

## Hjørne model m/2 skydedøre og 2 sideglas

Dusch		
Vare nr.	KIT sæt	Glas
037681	Skyde dørs KIT 3	8-10 mm.
037682	Side glas KIT 3	8-10 mm.
037683	Tætnings KIT 3	8-10 mm.

## Hjørne model m/1 skydedør og 2 sideglas

Dusch		
Vare nr.	KIT sæt	Glas
037684	Skyde dørs KIT 4	8-10 mm.
037685	Side glas KIT 4	8-10 mm.
037686	Tætnings KIT 4	8-10 mm.

# MAB integra

## Dusch beslag



8

### Beskrivelse

#### MAB integra dusch beslag

MAB GLAS fører et bredt udvalg af beslag og tilbehør til dusch.

- Hængsler og knopper
- Støttænger
- Glasbeslag
- Tætningslister og U-skiner

For andre muligheder eller forespørgsel, kontakt os.

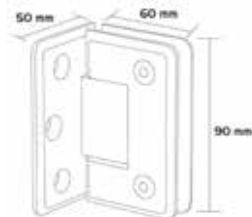
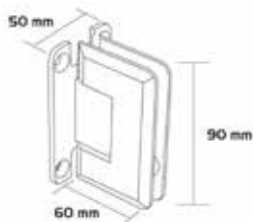

## Hængsel væg/glas



Dusch					
Vare nr.	Model	Type	Finish	Glas	
037437	181.30	90°	Børstet	8 - 10 mm.	
037438	181.29	90°	Krom	8 - 10 mm.	

## Hængsel væg/glas



Dusch					
Vare nr.	Model	Type	Finish	Glas	
037440	187.30	90°	Børstet	8 - 10 mm.	
037439	187.29	90°	Krom	8 - 10 mm.	

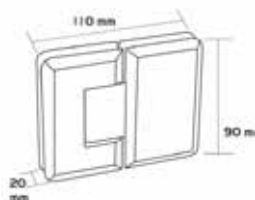

## Hængsel glas/glas



Dusch					
Vare nr.	Model	Type	Finish	Glas	
037435	182.30	180°	Børstet	8 - 10 mm.	
037434	182.29	180°	Krom	8 - 10 mm.	

## Hængsel glas/glas



Dusch					
Vare nr.	Model	Type	Finish	Glas	
037433	184.30	90°	Børstet	8 - 10 mm.	
037432	184.29	90°	Krom	8 - 10 mm.	

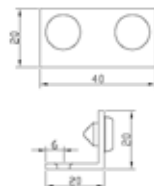
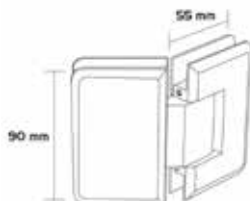

## Hængsel glas/glas



Dusch					
Vare nr.	Model	Type	Finish	Glas	
037430	185.30	135°	Børstet	8 - 10 mm.	
037429	185.29	135°	Krom	8 - 10 mm.	

## Dørstop

Dusch				
Vare nr.	Model		Finish	
018789	799 16 R		Krom	



## Bruseknop Ø30

Dusch				
Vare nr.	Model	Boring	Finish	Glas
037443	Ø30	Ø8 mm.	Børstet	6 - 10 mm.
037442	Ø30	Ø8 mm.	Krom	6 - 10 mm.

## Bruseknop Ø22

Dusch				
Vare nr.	Model	Boring	Finish	Glas
018862	3250	Ø8 mm	Børstet	6 - 10 mm.
018794	3250	Ø8 mm	Krom	6 - 10 mm.



## Bruseknop Ø40

Dusch				
Vare nr.	Model	Boring	Finish	Glas
018855	3259	Ø16 mm	Børstet	6 - 10 mm.
018853	3259	Ø16 mm	Krom	6 - 10 mm.

## Bruseknop Ø40

Dusch				
Vare nr.	Model	Boring	Finish	Glas
018811	3266	Ø16 mm	Børstet	6 - 10 mm.
018792	3266	Ø16 mm	Krom	6 - 10 mm.

8



## Bruseknop Ø40

Dusch				
Vare nr.	Model	Boring	Finish	Glas
018771	3290	Ø8 mm	Krom	6 - 10 mm.

## Bruseknop Ø40

Dusch				
Vare nr.	Model	Boring	Finish	Glas
018696	3267	Ø10 mm	Børstet	6 - 10 mm.
018699	3267	Ø10 mm	Krom	6 - 10 mm.





**Støttestang væg/glas**

Dusch				
Vare nr.	Model	Type	Finish	Glas
037601	Væg/glas	90°	Krom	8 - 10 mm.



**Støttestang glas/glas**

Dusch				
Vare nr.	Model	Type	Finish	Glas
037602	glas/glas	45°	Krom	8 - 10 mm.



**Støttestang væg/glas**

Dusch				
Vare nr.	Model	Type	Finish	Glas
037603	væg/glas	90°	Krom	8 - 10 mm.

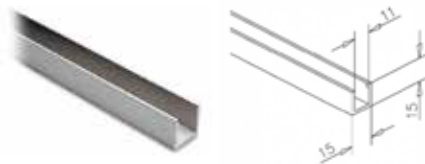

**U-profiler 15x15x15 mm.**

Alu./RS			
Vare nr.	Finish	Tykkelse	Længde
091000	Rustfri stål	1	2500
091007	Rustfri "LOOK"	2	5000
091012	Natur	2	6000
091013	Krom	2	5000



**U-profiler 20x20x20 mm.**

Alu./RS			
Vare nr.	Finish	Tykkelse	Længde
091001	Rustfri stål	1	2500
091004	Rustfri "LOOK"	2	5000
091005	Natur	2	6000
091014	Krom	2	5000

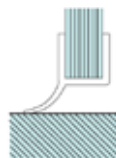

## Tætningsliste T-profil

Dusch			
Vare nr.	Model	Længde	Glas
037620	T Profil	2500 mm.	8 mm.
037621	T Profil	2500 mm.	10 mm.
037622	T Profil	2500 mm.	12 mm.

## Tætningsliste H-Profil

Dusch			
Vare nr.	Model	Længde	Glas
037625	h Profil	2500 mm.	10 mm.

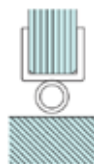
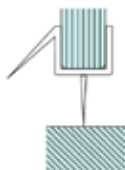

## Tætningsliste Dobbelt Profil

Dusch			
Vare nr.	Model	Længde	Glas
037630	2 x Profil	2500 mm.	8 mm.
037631	2 x Profil	2500 mm.	10 mm.

## Tætningsliste Bobbel Profil

Dusch			
Vare nr.	Model	Længde	Glas
037635	Bobbel Profil	2500 mm.	8 mm.
037636	Bobbel Profil	2500 mm.	10 mm.
037637	Bobbel Profil	3000 mm.	12 mm.

8



## Tætningsliste Magnet Profil

Dusch			
Vare nr.	Model	Længde	Glas
037640	Magnet 180°	2200 mm.	6 mm.
037641	Magnet 180°	2200 mm.	8 - 10 mm.
037642	Magnet 180°	2500 mm.	10 mm.

## Tætningsliste Stor Bobbel Profil

Dusch			
Vare nr.	Model	Længde	Glas
037645	Stor Bobbel Profil	2500 mm.	8-10 mm.

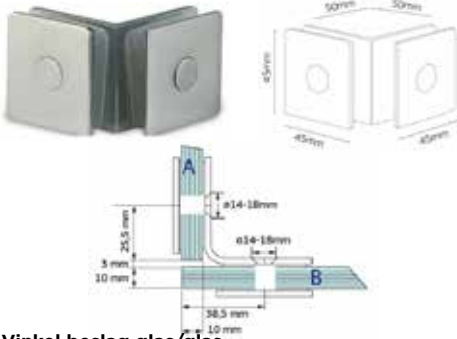

Vinkel beslag glas/glas

Dusch

Vare nr.	Model	Type	Finish	Glas
037455	Vinkel	90°	Krom	8 - 12 mm.

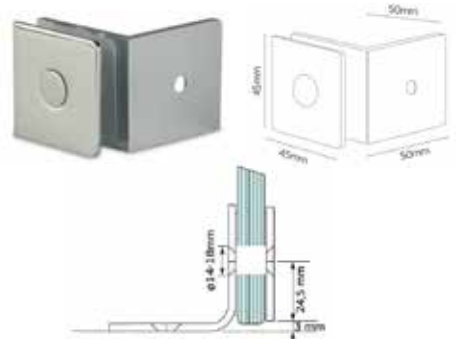

Væg beslag væg/glas

Dusch

Vare nr.	Model	Type	Finish	Glas
037456	Vægbeslag	90°	Krom	8 - 12 mm.

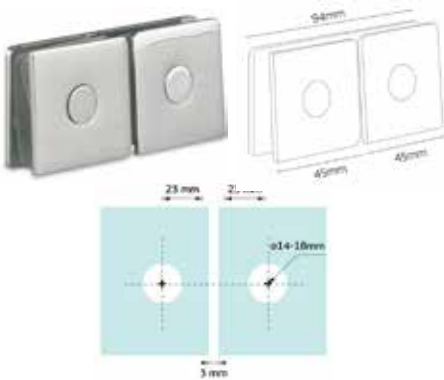

Dobbelt beslag glas/glas

Dusch

Vare nr.	Model	Type	Finish	Glas
037457	Dobbelt	180°	Krom	8 - 12 mm.



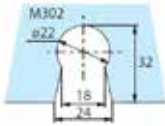

## Vægbeslag

Krom			
Vare nr.	Model	Finish	Glas
018780	3265	Krom	8 - 10 mm.

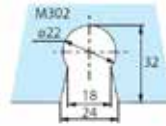
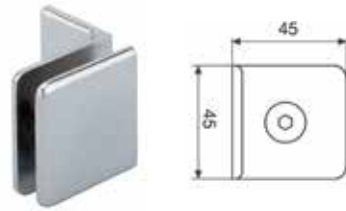

## Vinkel vægbeslag

Krom			
Vare nr.	Model	Finish	Glas
018847	3465	Krom	8 - 10 mm.

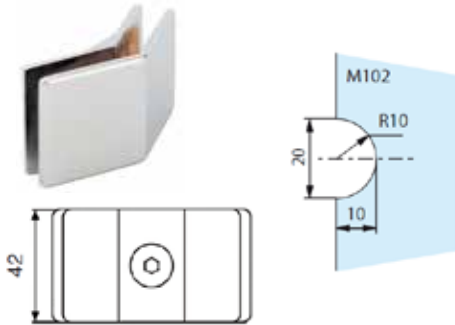

## 135° graders vinkelbeslag

Krom				
Vare nr.	Model	Type	Finish	Glas
018880	3257	135°	Krom	8 - 10 mm.

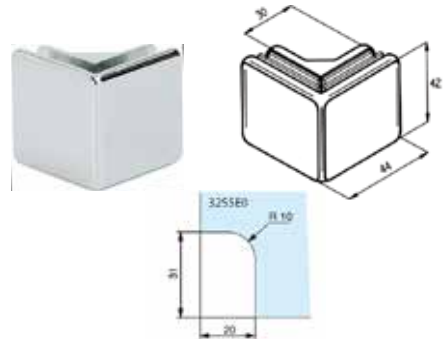

## 90° graders vinkelbeslag

Krom				
Vare nr.	Model	Type	Finish	Glas
018694	3256	90°	Krom	8 - 10 mm.

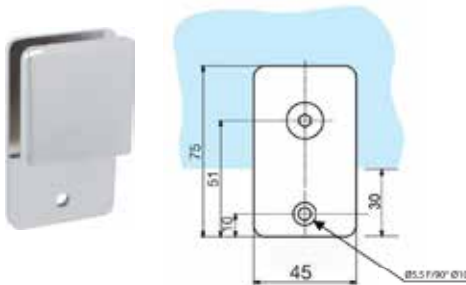

## Flad vægbeslag

Krom			
Vare nr.	Model	Finish	Glas
018624	3565	Krom	8 - 10 mm.



## Støtte beslag gulv/glas

Krom				
Vare nr.	Model	Højde	Finish	Glas
037450	Firkantet	50 mm	Krom	10 mm.
037451	Firkantet	100 mm	Krom	10 mm.

## Støtte beslag gulv/glas

Krom				
Vare nr.	Model	Højde	Finish	Glas
037454	Rund	50 mm	Krom	10 mm.
037485	Rund	100 mm	Krom	10 mm.

## Støtte beslag gulv/glas

Rustfri				
Vare nr.	Model	Højde	Finish	Glas
037452	Firkantet	50 mm	Børstet	10 mm.
037453	Firkantet	100 mm	Børstet	10 mm.

## Støtte beslag gulv/glas

Rustfri				
Vare nr.	Model	Højde	Finish	Glas
037486	Rund	50 mm	Børstet	10 mm.
037487	Rund	100 mm	Børstet	10 mm.

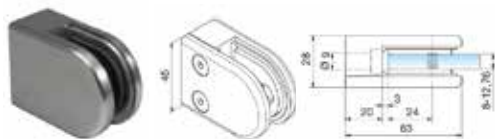

## Glasbeslag

Krom	Udendørs / Outdoor		
Vare nr.	Glas	Model	
017429	6 - 6,76 mm.	4819 ZN5	Type 2
017390	8 - 8,76 mm.	4818 ZN5	Type 2

## Glasbeslag

Krom	Udendørs / Outdoor		
Vare nr.	Glas	Model	
017300	8 - 8,76 mm.	4808 ZN5	Type 3
017353	10 - 10,76 mm.	4810 ZN5	Type 3
017332	12 - 12,76 mm.	4812 ZN5	Type 3

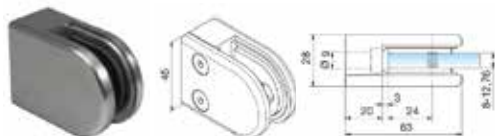
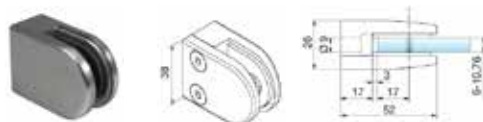

## Glasbeslag

Rustfri	Udendørs / Outdoor		
Vare nr.	Glas	Model	
017655	6 - 6,76 mm.	9312VA	Type 1
017656	8 - 8,76 mm.	9313VA	Type 1
017657	10-10,76 mm.	9314VA	Type 1

## Glasbeslag

Rustfri	Udendørs / Outdoor		
Vare nr.	Glas	Model	
017418	8 - 8,76 mm.	9302VA	Type 1
017417	10 - 10,76 mm.	9303VA	Type 1
017416	12 - 12,76 mm.	9304VA	Type 1

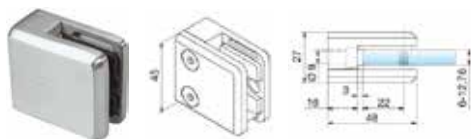
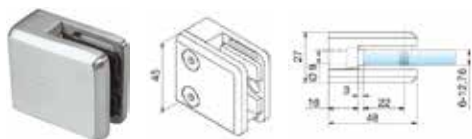

## Glasbeslag

Krom	Udendørs / Outdoor			
Vare nr.	Glas	Model	Type 1	Type 3
017597	8 - 8,76 mm.	4845 ZN5	Type 1	Type 3
017627	10 - 10,76 mm.	4846 ZN5	Type 1	Type 3

## Glasbeslag

Rustfri	Udendørs / Outdoor			
Vare nr.	Glas	Model	Type 1	Type 3
017644	6 - 6,76 mm.	9342VA	Type 1	Type 3
017641	8 - 8,76 mm.	9343VA	Type 1	Type 3
017643	10 - 10,76 mm.	9344VA	Type 1	Type 3



## Sikkerheds stift for rund og firkantet glasbeslag.

Rustfri	Udendørs / Outdoor			
Vare nr.	Type	Model	Hul i glas	Pakning
017801	1	4820VA	Ø10 mm.	10 stk.
017804	2	4824VA	Ø10 mm.	10 stk.
017784	3	9320VA	Ø10 mm.	10 stk.

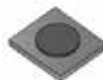

## Sikkerhedsplade for firkantet glasbeslag

Rustfri	Udendørs / Outdoor		
Vare nr.	Type	Model	Pakning
017807	1	4849VA	10 stk.
017808	2	4899VA	10 stk.





# MBM || MAB

Bilstrupvej 2  
7800 Skive  
Danmark

Tel +45 70 20 66 70  
info@mbm-mab.dk

[www.mbm-mab.dk](http://www.mbm-mab.dk)



**BESØG**  
vores hjemmeside på  
**[mbm-mab.dk](http://mbm-mab.dk)**